



TOSHIBA | **firetv**
Quick Setup Guide

Before using the TV, please read this guide carefully
and keep it for future reference.

Copyright statement

© 2021 Hisense Group All Rights Reserved.

Copyright protected material in this Quick Setup Guide may be owned by Hisense group, its contractors or other third parties. Unless otherwise stated, the exercise of any of the exclusive rights under the copyright laws in relation to the material on this site is not permitted without the consent of the rights owner or as otherwise covered by a statutory license.

No part of this publication may be stored, reproduced, transmitted or distributed, in whole or in part, in any manner, electronic or otherwise, whether or not for a charge or for other or no consideration, without the prior written permission of Hisense group. Requests for permission to store, reproduce, transmit or distribute materials may be made to the following address:

USA:

Hisense USA Corporation
7310 McGinnis Ferry Road
Suwanee, GA 30024

Hisense USA hereby declares that we are the licensed entities of using, promoting, advertising "TOSHIBA" trademark in relation to licensed products via permitted method. In no event shall anyone be allowed to use, transfer, reproduce, distribute, or transmit in any manner any materials under "TOSHIBA" without written consent by us.

Disclaimer

Disclaimer: Subscriptions or other payments may be required to access content through some applications. Some or all of the included or downloaded application services in this Toshiba device may not function depending on the Internet connection, local limitations of included applications or other reasons outside of Hisense group's control. Hisense group EXPRESSLY DISCLAIMS RESPONSIBILITY FOR ANY APPLICATION SERVICE FROM FUNCTIONING AT ANY TIME, FOR CONTENT IN ANY APPLICATION SERVICE, FOR DISRUPTIONS OF SERVICE, LOCAL OR REGIONAL LIMITATIONS, WARRANTIES OF TITLE, NO INFRINGEMENT, AND FOR IMPLIED WARRANTIES OF MERCHANTABILITY OR FITNESS FOR A PARTICULAR PURPOSE. By purchasing this device, you accept such Disclaimer without any claim on Hisense group at any time.

This Quick Setup Guide supports the following models:

55M550KU / 65M550KU / 75M550KU

Table of Contents

What's in the box	3
Getting started	4
Step 1. Attach stand or mount.....	4
Step 2. Connect devices to your TV	7
Step 3. Get to know controls.....	10
Step 4. Power on the TV	15
Step 5. Complete the first-time setup.....	15
Step 6. Enjoy your TV!	15
Troubleshooting	16
Product Specifications	17
Certification and Compliance.....	19
AMAZON TERMS & POLICIES.....	21

Congratulations on the purchase of your Toshiba TV! Please use one of the following methods below to contact us:

The model and serial number of the TV is located on the back and/or on one side of the TV. We recommend that you record this if you ever need service.

Country	Customer Care Center	Support Page	Register your TV
U.S.A	<ul style="list-style-type: none">• Phone: 1-888-407-0396• Hours of Operation: Monday - Friday: 9 AM to 9 PM EST Saturday - Sunday: 9 AM to 6 PM EST• Service Email: USAservice@toshiba-visual.com	<p>https://www.toshibatv-usa.com/support</p>  <p>For software issues, contact Amazon Fire TV Customer Service: www.amazon.com/deviceservices/support</p>	<p>https://www.toshibatv-usa.com/support/register/</p> 

Disclaimer: This Quick Setup Guide is intended as a general guideline to help you set up your TV. Images throughout this document are for illustrative purposes only and may differ from the actual product.

What's in the box

Your Toshiba TV comes with the following items:

- TV
- Power cord
- Remote control
- 2 base stands
- 1 IR Blaster cable
- Quick Setup Guide (this document)
- 1 set of AAA batteries
- Important Safety Information and Warranty Card
- 4 screws
- 1 RCA jack to AV Cable

IMPORTANT:

To prevent accidentally discarding items that came with your TV, be sure to **check ALL of the foam** in the carton box.

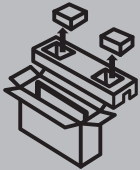

- Please check foam for accessories before discarding.
- Veuillez vérifier la mousse pour qu'il n'y ait pas d'accessoires avant de la jeter.
- Antes de desechar la espuma, asegúrese de retirar todos los accesorios.

You will also need the following items (which are not included) to set up your TV:

- Wireless router for Internet connectivity
- Phillips screwdriver to secure the TV stand
- HDMI and other types of cables to connect external devices to the TV
- Wall mount bracket and screws if you prefer to mount the TV on the wall

Getting started

Step 1. Attach stand or mount

Before you start using your TV, attach your TV stand or mount it on the wall.

CAUTION:

- Disconnect the AC power cord before installing a stand or a wall mount bracket.
- The display on your TV is fragile. Make sure the TV screen is not scratched or damaged by hard objects or from pressure.
- After the installation is complete, make sure the TV is steady on a table or firmly attached to a wall mount, before removing all protective film, if any.

Attach the TV stand

To attach the TV stand legs to your TV:

1. Carefully place your TV face down on a clean, soft, flat surface.
2. Insert the TV Base Stand into the bottom slots on your TV.
3. Use the screws provided to secure each stand tightly.

55"/65"

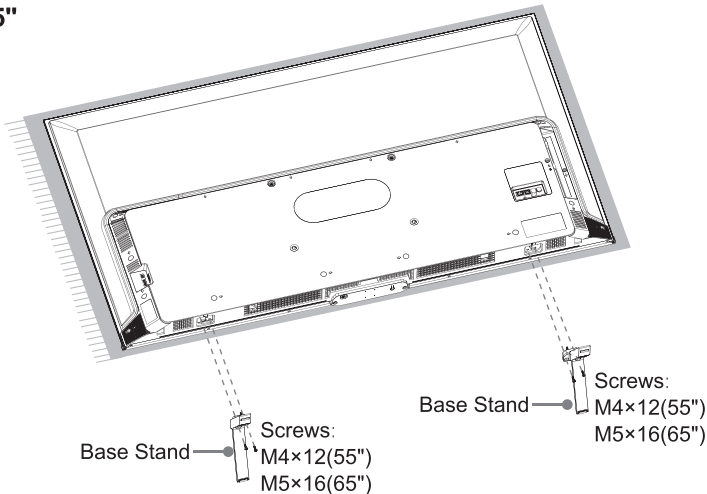

Note: If your table is long enough to place the TV, then insert the legs into the screw holes 'A' that are shown in the illustration. If your table is not long enough, then insert the legs into the screw holes 'B' that are shown in the illustration. Note that these two installation methods types cannot be mixed.

75"

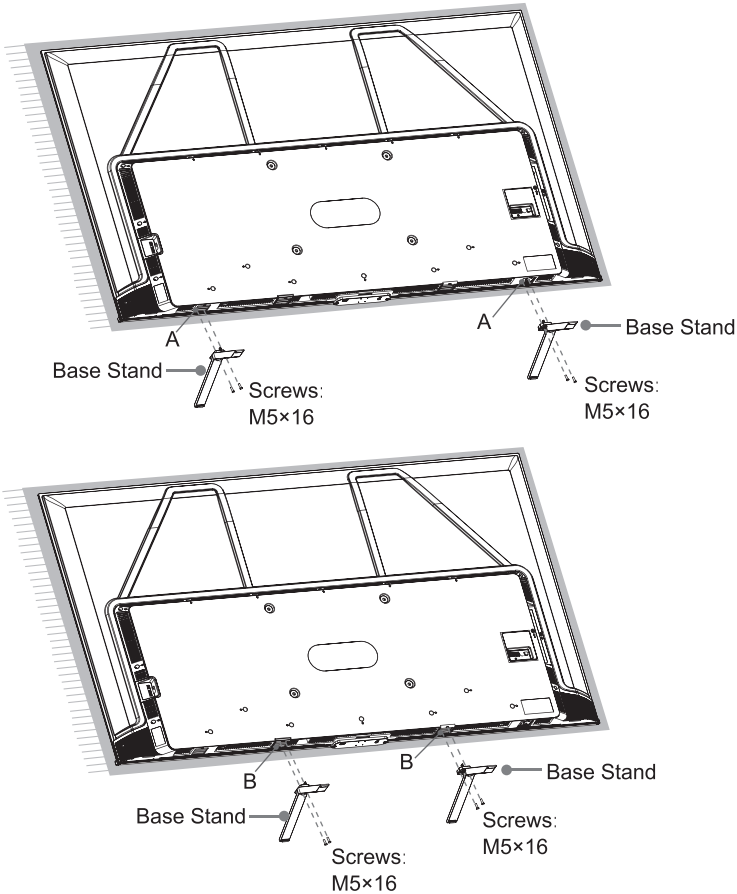

Use the cable clamp

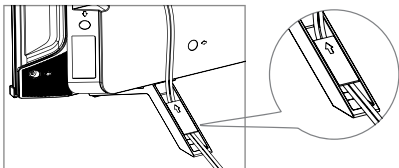

NOTE:

- The TV is designed with two cable clamps (left and right). You can tidy your external cables conveniently.
- Please follow the direction of the arrow to slide the covers up, put wires in the cable clamps and slide the covers down to recover.

Attach the wall mount bracket (not included)

Before you begin the third-party manufacturer instructions, be sure to do the following things:

1. Place the TV face down on a clean, safe and cushioned surface.
2. Remove the TV stand if you have already attached it.
3. Place spacers (not included) in the corresponding bracket holes.

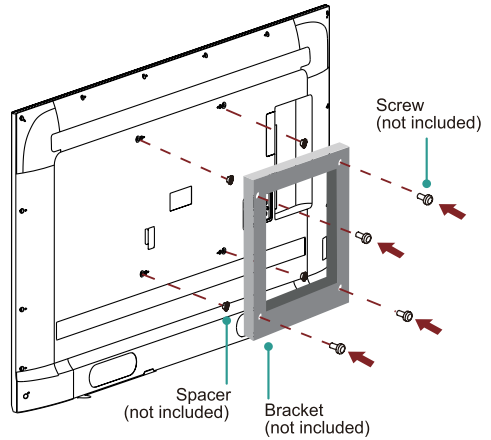

CAUTION:

- Follow instructions provided with the wall mount bracket. If it is not correctly mounted, the TV may fall and cause property damage or personal injury.
- When you attach the mount, be sure to use spacers (provided by the third-party manufacturer) between the TV and the bracket.
- To prevent internal damage to the TV and to ensure it is mounted securely, be sure to use fixing screws (not included) that are 9.5 - 11.5 mm (55"/65") / 8.0 - 10.0 mm (75") in length when measured from the attaching surface of the rear cover.
- The TV screen should be parallel with the vertical surface. Make sure the TV screen does not lean forward.

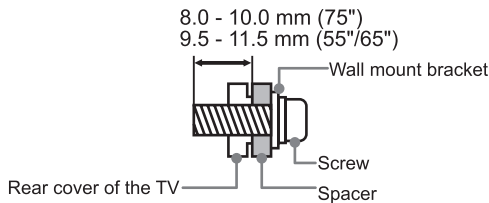
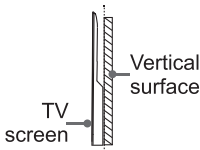

Wall mount hole pattern(mm)	300 × 200 (55") 400 × 200 (65") 400 × 300 (75")
Wall mount screw size	M6

NOTE:







- If you have additional questions, please contact the wall mount manufacturer or the retailer from which you purchased the TV.
- The diameter and length of the screws differ depending on the wall mount bracket model.

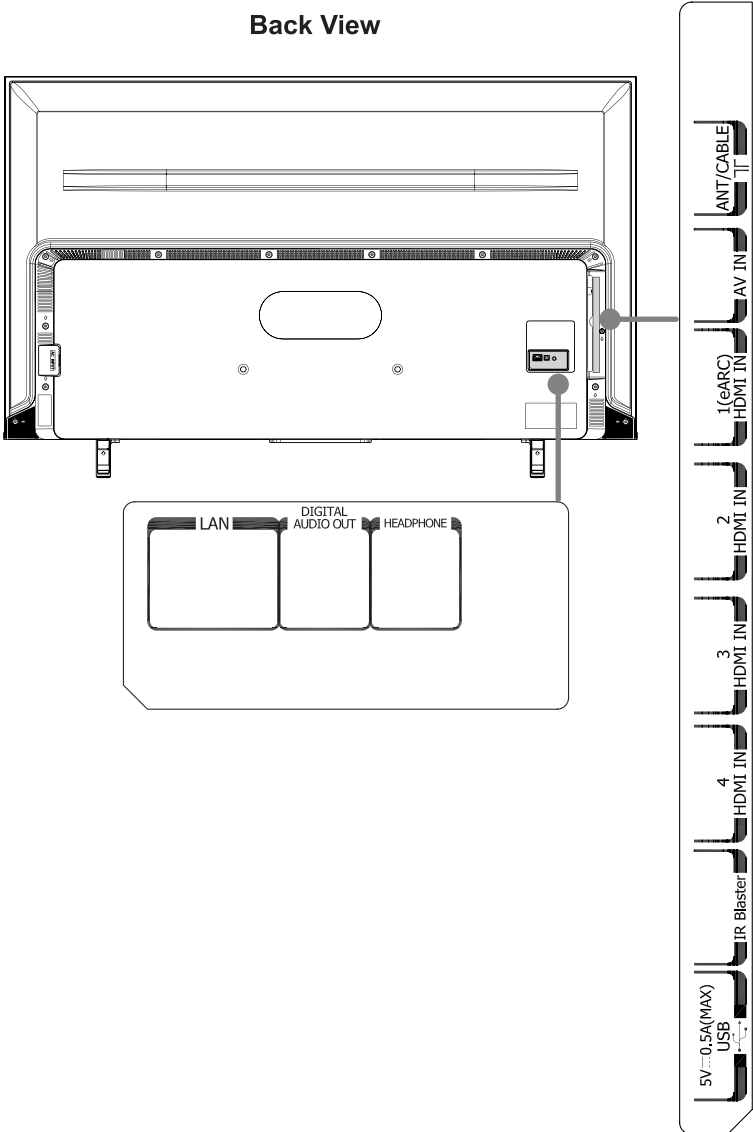

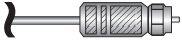
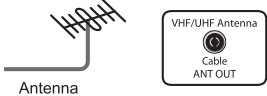

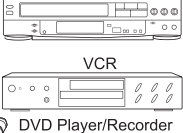

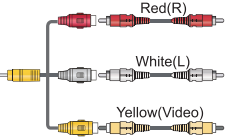
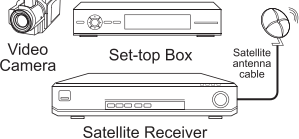

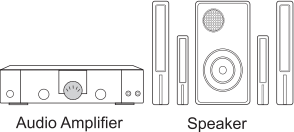
Step 2. Connect devices to your TV

Check to ensure that you have connected the right cables to the right ports securely. Loose connections can affect the quality of the picture image and color.

Back View



TV label	Port	Cable	External Equipment	Brief Description
ANT/CABLE				<p>Connect an outdoor VHF/UHF antenna.</p>
HDMI IN				<p>Connect a High Definition Multimedia Interface (HDMI) cable from an external device.</p>
AV IN				<p>Connect a composite video cable and left-right audio cables from an external AV device.</p>
DIGITAL AUDIO OUT				<p>Connect an optical cable from an external digital audio system.</p>

TV label	Port	Cable	External Equipment	Brief Description
HEADPHONE				<p>Connect headphones to hear audio from the TV. Headphones with microphones are not supported.</p>
USB			<p>Connect a USB device for browsing photos, music and movies. Hard disks with a total current consumption or impulse current consumption greater than 500mA are not supported.</p>	
LAN				<p>Connect an Ethernet cable to access a network or the Internet. The TV also has a wireless connectivity feature.</p>
IR Blaster				<p>Connect the IR Blaster cable to the IR Blaster port to control compatible soundbars and A/V receivers.</p>

Step 3. Get to know controls

Control on the TV

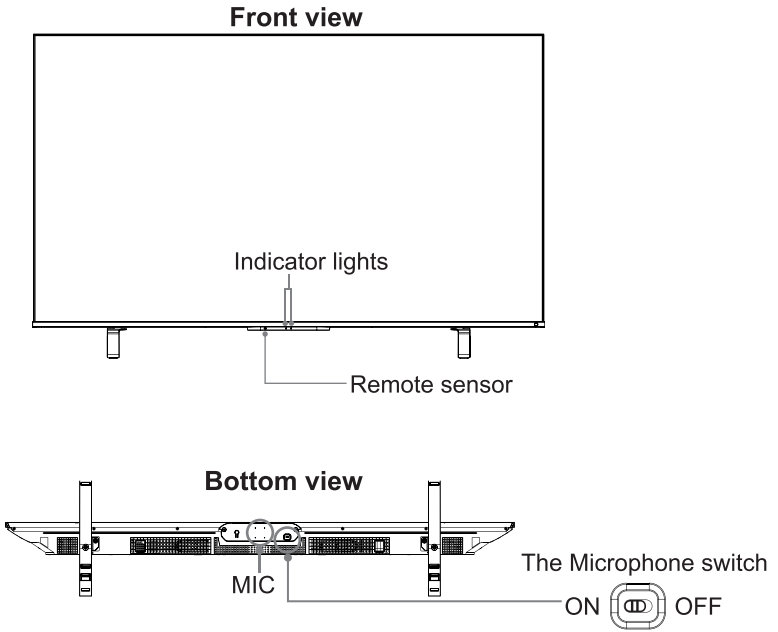

Introduction

This TV has microphones so you can use Alexa hands-free. Enjoy hands-free voice control of content, including search, play, pause, fast forward, and more. Now you can put down the remote and dive straight into your favorite movies and TV shows with just the sound of your voice. From across the room, say, “Alexa, play The Mandalorian on Disney+,” and Alexa will respond to your request. Switch inputs and go from watching your favorite TV show to the big game. You can also ask Alexa to check the weather, set timers and reminders, and more—even when the TV screen is off. Here are a few things that you can do with your Toshiba Fire TV:

To do this on your Toshiba FireTV...	Say this...
Play a movie or TV show Alexa can play content from a range of supported apps installed on your Fire TV.	“Watch [title].” “Play [title].” “Play [title] on [app].”
Change antenna channels Your Toshiba Fire TV can switch to TV channels that are received by an antenna.	“Switch to [input type].” “Tune to [channel number] on TV.” “Tune to [channel name] on TV.”

To do this on your Toshiba FireTV...	Say this...
<p>Live TV controls</p> <p>For supported apps that feature Live TV access, you can use Alexa to change channels or control playback for on-demand programming. You can also use Alexa to navigate to the Channel Guide and the Live tab.</p>	<p>“Go to [channel/network] on [app].”</p> <p>“Watch [channel/network].”</p> <p>“Go to Channel Guide.”</p> <p>“Go to Live.”</p>
<p>Search for movies and TV shows</p> <p>Alexa can find movies and TV shows from a range of supported installed apps.</p>	<p>“Search for [title].”</p> <p>“Find [title/genre].”</p> <p>“Show me [tv shows/movies] with [actor].”</p>
<p>Alexa requests</p> <p>See the responses on Fire TV when you make an Alexa request.</p>	<p>“Show me the weather.”</p> <p>“Show me my To Do List.”</p> <p>“Show me songs by [artist].”</p> <p>“Show me restaurants nearby.”</p>
<p>Control your TV</p> <p>Alexa can turn on your TV and dive straight into your favorite movies and TV shows with the sound of your voice.</p>	<p>“Alexa, turn on TV.”</p> <p>“Alexa, increase the volume.”</p> <p>“Alexa, pause.”</p>

How to turn off the microphones?

Alexa is designed to protect your privacy. For example, you can slide the Microphone switch on the bottom of the TV to turn off or on the microphones. When set to OFF, power will be disconnected from the microphones, you will see a red LED on the front of your TV, and the TV cannot record or stream audio requests to the cloud even if you say the wake word. If you have an Alexa-enabled remote control, you will still be able to use Alexa through the remote. Alexa doesn't begin listening until your TV detects the wake word (for example, “Alexa”). A blue light lets you know when audio is being sent to Amazon's secure cloud.

For best Alexa performance

- To ensure that Alexa can hear you, this TV should be unobstructed and not in a closed cabinet.
- Do not place a sound bar or other external speakers directly in front of or behind the TV. If you must place a sound bar or external speakers in front of or behind the TV, please leave **1 foot gap** between them and the TV.
- Your TV speakers will cause vibration. Placing objects on or near the TV may cause those objects to vibrate which may affect how well Alexa can hear you.

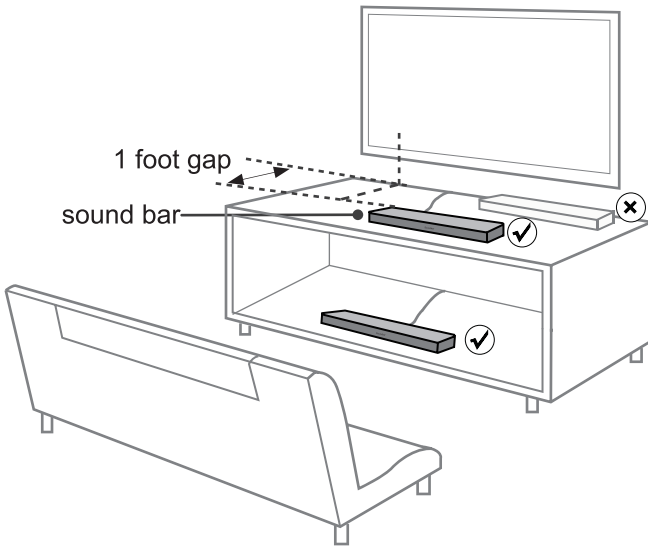

Get your remote ready

The following table shows the buttons on your remote control and describes what they are for.

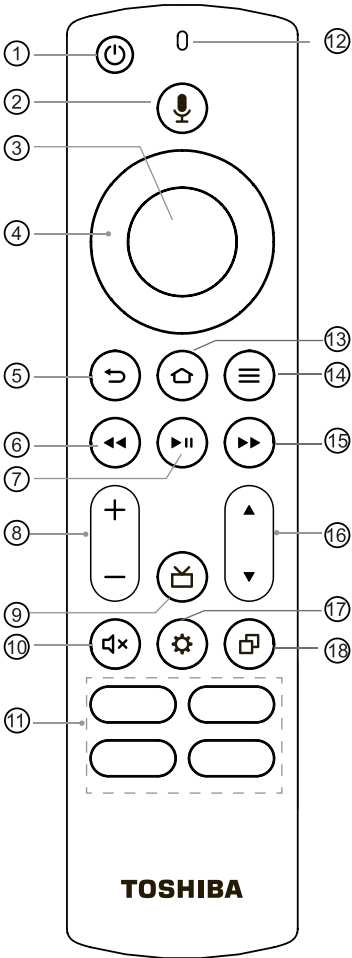

- ① **POWER:** Turn your TV on or off
- ② **Voice button:** Hold down the Voice button to activate the microphone
- ③ **Select:** Confirm a selection or action
- ④ **D-pad** (up/down/left/right navigation buttons)
- ⑤ **Back:** Return to the previous place in the menu or app
- ⑥ **REWIND:** Rewind streaming video
- ⑦ **PLAY/PAUSE:** Pause or resume playback. This button is also used to activate and use the Live TV pause feature
- ⑧ **VOLUME + / VOLUME -:** Increase/decrease the volume
- ⑨ **Guide:** Open the Live TV Channel Guide
- ⑩ **MUTE:** Mute or un-mute the sound
- ⑪ **App buttons:** Quick access buttons to apps
- ⑫ **Microphone:** Receive the voice
- ⑬ **HOME:** Display your TV's Home screen
- ⑭ **MENU:** The button for the Menu
- ⑮ **FAST FORWARD:** Fast forward streaming video
- ⑯ **Channel ▲ / Channel ▼:** Switch channel
- ⑰ **Quick Settings:** Activate quick settings overlay
- ⑱ **Recents:** Open a row of recently watched content so you can easily switch between content

NOTE:

- The picture is only for reference. Check information according to the actual remote control.

Insert the batteries

Remove the battery door and insert the two AAA batteries into your Alexa Voice Remote.

Important information about the remote and batteries

- **Discard batteries in a designated disposal area. Do not throw them into a fire.**
- **Remove old batteries immediately to prevent them from leaking into the battery compartment.**
- **If you do not intend to use the remote control for a long time, then remove the batteries.**
- **Battery chemicals can cause a rash. If the batteries leak, clean the battery compartment with a cloth. If chemicals touch your skin then wash it immediately.**
- **Do not mix old and new batteries.**
- **Only use new 1.5v alkaline or 1.2NiMH rechargeable AAA sized batteries. Do not mix alkaline or rechargeable NiMH batteries.**
- **Do not continue using the remote if it gets warm or hot.**
- **Call our Support Center immediately on the support website.**

Using your cable set-top box or satellite receiver remote as a ‘universal’ remote

If you prefer to use your Cable Set-top Box or Satellite Receiver Remote as a ‘universal’ remote, then visit the Support page to view a list of the codes.

Step 4. Power on the TV

Connect your power cord to the TV and plug it into a power outlet.

Your TV will display a launch screen showing the Toshiba logo.

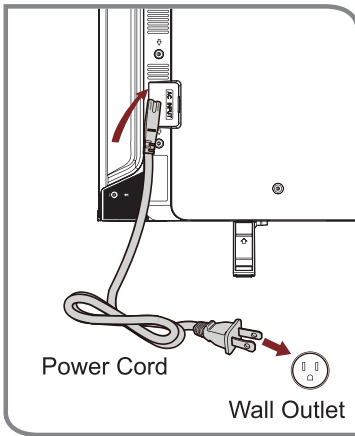

Step 5. Complete the first-time setup

The first time you turn on your TV, there is a guided setup to make it easy to connect your TV to the Internet and complete the setup of your TV.

Your TV will automatically pair with your new Alexa Voice Remote.

1. If there are issues with the remote pairing, you will be prompted to pair your remote by pressing the **HOME** button. If you continue to have issues, try re-inserting or replacing your batteries.
2. Select your Wi-Fi network from the list of Wi-Fi networks displayed on the screen.

NOTE:

- If your Wi-Fi network is password protected, please have your Wi-Fi network password handy to connect your TV to the Internet. If your network is hidden, select the **Join Other Network**. If required, enter your network password using the on-screen keyboard.

Step 6. Enjoy your TV!

Now that you've completed the first-time setup, your Home screen is your starting point for using your TV. Your Toshiba TV provides a variety of entertainment options, so you'll always find something new. Use your TV to watch live channels, access video on demand to watch movies, and much more.

Troubleshooting

If you are having trouble with your TV, first try turning it off and on again. If this does not fix the problem, check the tips in the following table. If your problem is not listed in the following table, then contact us at one of the phone numbers on Page 2.

Issues	Possible solutions
No sound or picture	<ul style="list-style-type: none"> • Check if the power cord is plugged into a powered AC outlet. • Press the Power button on the remote control to activate the unit from 'Standby' mode. • Check to see if the LED light is on or not. If it is, then the TV is receiving power.
I have connected an external source to my TV and I get no picture and/or sound.	<ul style="list-style-type: none"> • Check for the correct output connection on the external source and for the correct input connection on the TV. • Make sure you have made the correct selection for the input mode for the incoming signal.
When I turn on my TV, there is a delay for a few seconds before the picture appears. Is this normal?	<ul style="list-style-type: none"> • Yes, this is normal. The TV is initializing and searching for previous setting information.
The picture is normal but there is no sound	<ul style="list-style-type: none"> • Check the volume settings. • Check if 'Mute' mode is set to On.
Sound but no picture or black and white picture	<ul style="list-style-type: none"> • If the picture is black and white, unplug the TV from the AC outlet and replug it after 60 seconds. • Check that the Color is set to 50 or higher. • Try different TV channels.
The sound and/or picture is distorted or appears wavy	<ul style="list-style-type: none"> • An electric appliance may be affecting the TV. Turn off any appliances that are nearby and move it farther away from the TV. • Insert the power plug of the TV set into another power outlet.
The sound and picture is blurry or cuts out	<ul style="list-style-type: none"> • If using an external antenna, check the direction, position and connection of the antenna. • Adjust the direction of your antenna or reset or fine tune the channel.
A horizontal or vertical stripe appears on the picture and/or the picture is shaking	<ul style="list-style-type: none"> • Check if there is an appliance or electric tool nearby that is causing interference.
The plastic cabinet makes a "clicking" type of sound	<ul style="list-style-type: none"> • The 'click' sound can occur when the temperature of the television changes. This change causes the television cabinet to expand or contract, which makes the sound. This is normal and the TV is OK.
The remote control does not work	<ul style="list-style-type: none"> • Confirm that TV still has power and is operational. • Change the batteries in the remote control. • Check if the batteries are correctly installed.

Product Specifications

Model Name		55M550KU	65M550KU
Dimension (W × H × D)	Without Stand	48.5 × 28.1 × 3.0 inches (1232 × 713 × 76 mm)	57.0 × 33.0 × 3.0 inches (1447 × 839 × 76 mm)
	With Stand	48.5 × 30.7 × 10.5 inches (1232 × 781 × 267 mm)	57.0 × 35.7 × 10.9 inches (1447 × 906 × 277 mm)
Weight	Without Stand	31.5 lbs (14.3 kg)	41.2 lbs (18.7 kg)
	With Stand	32.4 lbs (14.7 kg)	42.3 lbs (19.2 kg)
TV Stand Width(W × D)		34.3 × 10.5 inches (872 × 267 mm)	40.7 × 10.9 inches (1034 × 277 mm)
Class		55"	65"
Active Screen Size (Diagonal)		54.6 inches	64.5 inches
Screen Resolution		3840 × 2160	
Audio Power		10 W + 10 W	
Power consumption		180 W	190 W
Power Supply		120 V ~ 60 Hz	
Connectivity		Built-in Wireless feature (2x2 dual band)	
Ports		4 HDMI ports, 1 USB port, 1 LAN port for Ethernet, 1 Digital Audio Output, 1 RF Input, 1 Headphone Audio Output, 1 AV IN port, 1 IR Blaster port	
Receiving Channels		VHF: 2 - 13, UHF: 14 - 69, CATV: 1 - 125 Digital Terrestrial Broadcast (8VSB): 2 - 69 Digital cable (64/256 QAM): 1 - 135	
Tuner Type		Frequency synthesized	
Receiving System		Analog: NTSC Digital: ATSC/QAM	
Operating Temperature		41°F - 95°F (5°C - 35°C)	
Operating Humidity		20% to 80% non-condensing	
Storage Temperature		5°F to 113°F (-15°C to 45°C)	
Storage Humidity		10% to 70%, non-condensing	

Disclaimer: All products, product specifications, and data are subject to change without notice to improve reliability, function, design or otherwise.

Product Specifications

Model Name		75M550KU
Dimension (W × H × D)	Without Stand	65.9 × 37.8 × 3.1 inches (1675 × 960 × 78 mm)
	With Stand	65.9 × 40.7 × 14.4 inches (1675 × 1035 × 367 mm)
Weight	Without Stand	61.5 lbs (27.9 kg)
	With Stand	63.1 lbs (28.6 kg)
TV Stand Width(W × D)		23.2 × 14.4 / 45.5 × 14.4 inches (590 × 367 / 1156 × 367 mm)
Class		75"
Active Screen Size (Diagonal)		74.5 inches
Screen Resolution		3840 × 2160
Audio Power		10 W + 10 W
Power consumption		280 W
Power Supply		120 V ~ 60 Hz
Connectivity		Built-in Wireless feature (2x2 dual band)
Ports		4 HDMI ports, 1 USB port, 1 LAN port for Ethernet, 1 Digital Audio Output, 1 RF Input, 1 Headphone Audio Output, 1 AV IN port, 1 IR Blaster port
Receiving Channels		VHF: 2 - 13, UHF: 14 - 69, CATV: 1 - 125 Digital Terrestrial Broadcast (8VSB): 2 - 69 Digital cable (64/256 QAM): 1 - 135
Tuner Type		Frequency synthesized
Receiving System		Analog: NTSC Digital: ATSC/QAM
Operating Temperature		41°F - 95°F (5°C - 35°C)
Operating Humidity		20% to 80% non-condensing
Storage Temperature		5°F to 113°F (-15°C to 45°C)
Storage Humidity		10% to 70%, non-condensing

Disclaimer: All products, product specifications, and data are subject to change without notice to improve reliability, function, design or otherwise.

Certification and Compliance

FCC Notice

This device has been tested and found to comply with the limits for a Class B digital device pursuant to Part 15 of the FCC Rules. These limits are designed to provide reasonable protection against harmful interference in a residential installation. This device generates, uses, and can radiate radio frequency energy and, if not installed and used in accordance with the instructions, may cause harmful interference to radio communications.

However, there is no guarantee that interference will not occur in a particular installation. If this device does cause harmful interference to radio or television reception, which can be determined by turning the device off and on, the user is encouraged to try to correct the interference by one or more of the following measures:

- Reorient or relocate the receiving antenna.
- Increase the separation between the device and receiver.
- Connect the device into an outlet on a circuit different from that to which the receiver is connected.
- Consult the dealer or an experienced radio/TV technician for help.

NOTE: The manufacturer is not responsible for any radio or TV interference caused by unauthorized modifications to this equipment. Such modifications could void the user's authority to operate the equipment.

The Wi-Fi Module complies with FCC radiation exposure limits set forth for an uncontrolled environment. This device should be installed and operated with a minimum distance of 20 centimeters between the radiator and your body.

Declaration of Conformity

Trade Name: Toshiba

Model: 55M550KU / 65M550KU / 75M550KU

Responsible Party: Hisense USA Corporation

Address: 7310 McGinnis Ferry Road, Suwanee, GA 30024

Telephone Number: 678-318-9060

This device complies with Part 15 of the FCC Rules. Operation is subject to the following two conditions: (1) this device may not cause harmful interference, and (2) this device must accept any interference received, including interference that may cause undesired operation.



The terms HDMI and HDMI High-Definition Multimedia Interface, and the HDMI Logo are trademarks or registered trademarks of HDMI Licensing Administrator, Inc. in the United States and other countries.



Dolby, Dolby Vision, Dolby Audio, and the double-D symbol are trademarks of Dolby Laboratories Licensing Corporation. Manufactured under license from Dolby Laboratories. Confidential unpublished works. Copyright © 1992–2021 Dolby Laboratories. All rights reserved.



For DTS patents, see <http://patents.dts.com>. Manufactured under license from DTS Licensing Limited. DTS, DTS-HD Master Audio, DTS-HD, Virtual:X, and the DTS-HD logo are registered trademarks or trademarks of DTS, Inc. in the United States and other countries. © 2020 DTS, Inc. ALL RIGHTS RESERVED.

NOTE:

- This product does not support decoding of DTS CD bitstreams. Playback of this format may produce undesirable noise.



Environmental Protection

This mark indicates that this product should not be disposed together with other domestic garbage, to avoid damage to the environment or human health due to the disposal of uncontrolled waste. Recycle it responsibly for promoting the sustainable reuse of material resources. To return your used device, please use the return systems available in your location or contact the vendor where you purchased your product they could take this product for recycling and protection of the environment.

©2021. All rights reserved.

Amazon, Fire, and all related marks are trademarks of Amazon.com, Inc. or its affiliates.

AMAZON TERMS & POLICIES

Before using Fire TV Edition, please read the terms located at www.amazon.com/deviceservices/support. Please also read all terms and policies for services related to Fire TV Edition, including but not limited to Amazon's Privacy Notice located at www.amazon.com/privacy, Amazon's Conditions of Use located at www.amazon.com/conditionsofuse, and any other terms or usage provisions available at www.amazon.com/deviceservices/support. All terms, rules, notices, policies, and provisions are, collectively, the "Agreements." By using Fire TV Edition, you agree to be bound by the terms of the Agreements.